

STEEL STUD, TRIMS AND ACCESSORIES FOR DRYWALL CONSTRUCTION

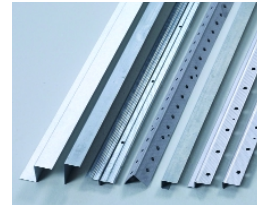

**BAILEY**  
METAL PRODUCTS LIMITED



MONTREAL · TORONTO · CALGARY · EDMONTON · VANCOUVER

THE STRENGTH WITHIN



## STEEL STUD AND TRACK - FOR DRYWALL PARTITIONS

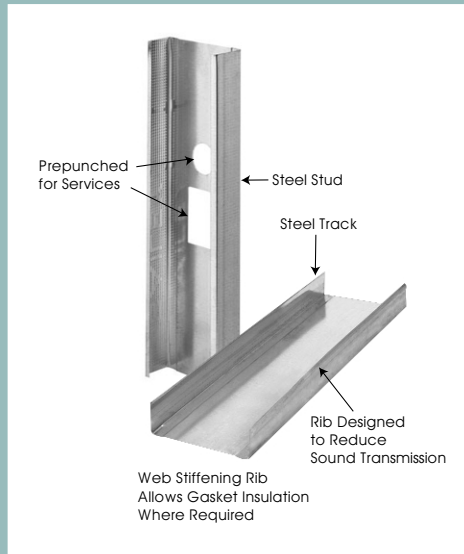

TAKE ADVANTAGE OF THE SAVINGS IN TIME AND MONEY OFFERED BY STEEL STUD CONSTRUCTION.

### A FEW OF THE MANY BENEFITS ARE:

- steel studs are manufactured to exact size requirements
- steel studs are pre-punched for services
- steel studs do not warp, eliminating nail popping
- steel is non-combustible
- steel studs and track partitions are lightweight and extremely fast to install

## METRIC/IMPERIAL CONVERSION TABLE

STUD & TRACK SIZES				
IMPERIAL	1 5/8"	2 1/2"	3 5/8"	6"
METRIC	41 mm	64 mm	92 mm	152 mm

## INTERIOR NON-COMPOSITE LIMITING WALL HEIGHT TABLE

STUD DESIGNATION	SPACING o.c.(in.)	5 psf			7.5 psf			10 psf		
		L/120	L/240	L/360	L/120	L/240	L/360	L/120	L/240	L/360
250S125-18	12	12'-6"	10'-6"	9'-2"	10'-2"	9'-2"	8'-0"	8'-10"	8'-4"	7'-4"
	16	10'-10"	9'-6"	8'-4"	8'-10"	8'-4"	7'-4"	7'-7"	7'-7"	6'-7"
	24	8'-10"	8'-4"	7'-4"	7'-2"	7'-2"	6'-4"	6'-2"	6'-2"	5'-10"
362S125-18	12	15'-1"	13'-7"	11'-11"	12'-5"	11'-11"	10'-5"	10'-8"	10'-8"	9'-5"
	16	13'-1"	12'-5"	10'-10"	10'-8"	10'-8"	9'-5"	9'-4"	9'-4"	8'-7"
	24	10'-8"	10'-8"	9'-5"	8'-8"	8'-8"	8'-4"	7'-7"	7'-7"	7'-6"

**NOTE: 600S125-18 walls must be constructed with full sheathing, see note 2 below and use corresponding Composite Table.**

### Notes:

- 1) Studs are 0.0179 in. base steel thickness.
- 2) Limiting heights are based on continuous support of each flange over the full height of the stud.
- 3) Heights based on steel properties only, calculated in accordance with CSA-S136-2002.

## INTERIOR COMPOSITE LIMITING WALL HEIGHT TABLE

STUD DESIGNATION	SPACING o.c.(in.)	5 psf			7.5 psf			10 psf		
		L/120	L/240	L/360	L/120	L/240	L/360	L/120	L/240	L/360
250S125-18	12	14'-5"	12'-0"	10'-5"	11'-10"	10'-5"	9'-1"	10'-2"	9'-6"	8'-4"
	16	12'-11"	11'-4"	9'-10"	10'-7"	9'-10"	8'-6"	9'-2"	8'-11"	-
	24	11'-4"	10'-5"	9'-1"	9'-4"	9'-1"	-	8'-1"	8'-1"	-
362S125-18	12	16'-11"	15'-4"	13'-4"	13'-7"	13'-2"	11'-6"	11'-8"	11'-8"	10'-5"
	16	15'-1"	14'-4"	12'-5"	12'-1"	12'-1"	10'-10"	10'-5"	10'-5"	9'-8"
	24	13'-0"	13'-0"	11'-5"	10'-5"	10'-5"	9'-11"	8'-11"	8'-11"	8'-11"
600S125-18	12	21'-5"	21'-5"	19'-6"	17'-2"	17'-2"	16'-10"	14'-10"	14'-10"	14'-10"
	16	19'-0"	19'-0"	18'-2"	15'-2"	15'-2"	15'-2"	13'-0"	13'-0"	13'-0"
	24	16'-2"	16'-2"	16'-2"	12'-11"	12'-11"	12'-11"	11'-0"	11'-0"	11'-0"

### Notes:

- 1) Studs are 0.0179 in. base steel thickness.
- 2) Composite wall sheathed both sides full height with 1/2" gypsum wallboard.
- 3) Sheathing attached with #6 screws minimum at 12" o.c. maximum
- 4) Maximum heights are also applicable to walls sheathed with gypsum board greater than 1/2 in. thick and multiple layers of gypsum board.

Reproduced with the permission of CSSBI. The Stud Designation follows the industry standard format.



## DRYWALL CORNER BEAD & METAL TRIMS

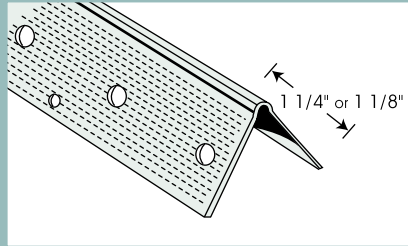

### D-100-90° DRYWALL CORNER BEAD

This Drywall Corner Bead, manufactured using sturdy zinc-coated steel, provides excellent protection to external corners. The holes and knurled surface provide an excellent "key" for the joint compound. This Corner Bead can be applied either with nails, screws or clinch-on tools.

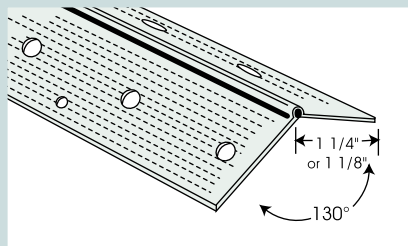

### D-100-130° DRYWALL CORNER BEAD

This Drywall Corner Bead was specifically designed to provide protection to external 130° wide angle corners. 130° Corner Bead is available from stock with 1 1/4" or 1 1/8" flanges. (This is to fit 135° corners)

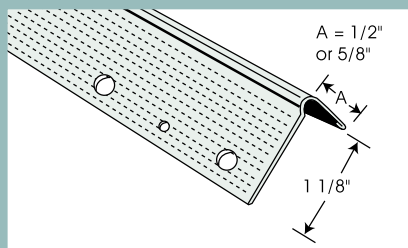

### D-200 DRYWALL METAL TRIM

For use with 1/2" and 5/8" Wallboard

This Drywall Trim provides a neat finish and solid protection to gypsum wallboard at window and door jambs where wood trim is omitted. Holes in the flange provide a "key" for the joint cement.

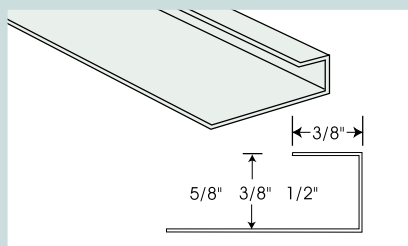

### D-400 METAL TRIM

Provides edge protection at window and door openings, and where wallboard butts against concrete or other materials. Finishing cement is optional. (For use with 3/8", 1/2" or 5/8" wallboard)

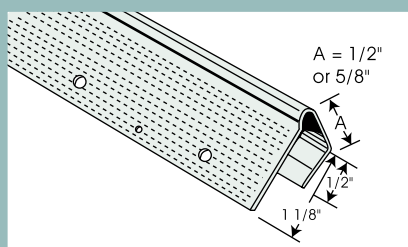

### 4411 CHANNEL TRIM

A tapeable steel casing that provides maximum protection at door and window jambs. Quickly installed by nailing through channel and board into the jamb or framing. (For use with 1/2" or 5/8" wallboard)



## DEEP LEG TRACKS

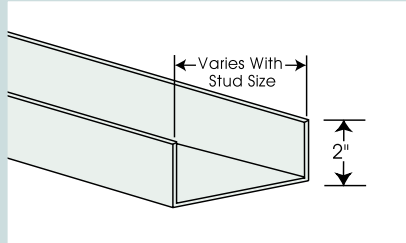

### 2" DEEP LEG TRACK

Bailey 2" Deep Leg Track is designed for applications where wall height will vary slightly along its length, due to uneven concrete, etc.

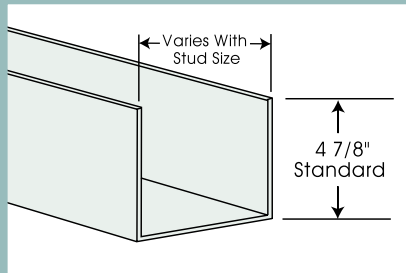

### CARPET BASE TRACK

Bailey Carpet Base Track is manufactured with an extra deep leg. This leg can be varied to suit, while stocked in 4 7/8" depth for 2 1/2" and 3 5/8" stud. Available in some locations.

The most common application is to provide a backing for the attachment of carpet where it is extended up the wall.

## DRYWALL REVEAL TRIMS

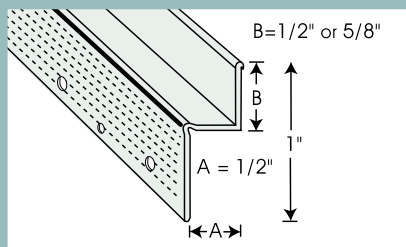

### D-300 DRYWALL REVEAL TRIM

This Drywall Trim is designed to provide crisp clean reveals around openings or at ceilings and floors. The holes and knurled surface provides an excellent "key" for finishing with joint compound. For use with 1/2" drywall to provide a 1/2" or 5/8" reveal.

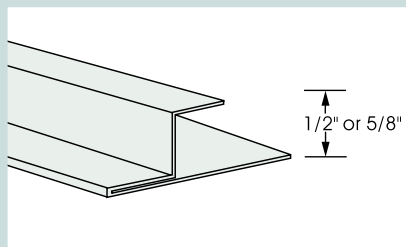

### D-800 DRYWALL REVEAL TRIM

A solid reveal trim for use at doors, windows, ceilings, etc. The surface is ready for painting and additional finishing is not required. Available for 1/2" or 5/8" drywall. D-800 provided with a 1/2" reveal as a standard. Custom reveals are also readily available.



## TRIMS & SPECIAL PROFILES

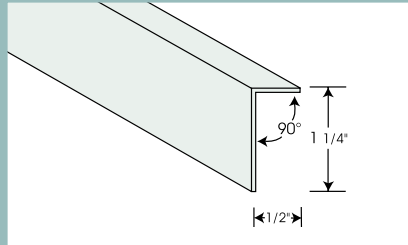

### D-500 ANGLE TRIM

This 1 1/4" x 1/2" Angle Trim finishes and protects drywall edges. Easily applied using standard drywall adhesive after the board is in place.

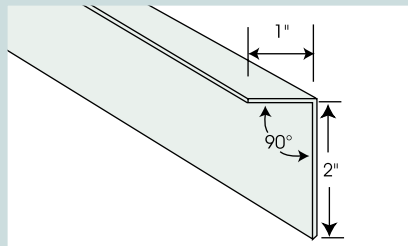

### D-700 ANGLE FRAMING TRIM

A very versatile 1" x 2" angle or L-track, for use in column framing, bulkheads etc.

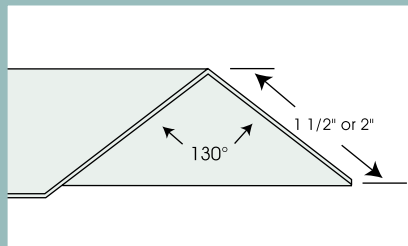

### 130° ANGLE TRIMS

Available from stock with 2" x 2" or 1 1/2" x 1 1/2" flanges. Designed for 130° external corner construction. Flange size and angle can be varied to meet design criteria. (This is to fit 135° corner)

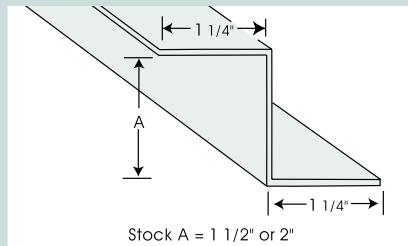

### D-900 Z TRIM

A trim designed to hold rigid insulation in place and provide a face to fasten finishing (drywall, siding, etc.). Suitable for interior or exterior application. Stocked for 1 1/2" and 2" insulation thickness. Available in steel thicknesses up to 68 mils.

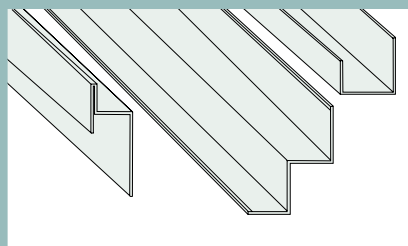

### SPECIAL PROFILES

Special profiles and custom shapes are manufactured from different steel thicknesses and widths up to 68 mils. Girts, battens and purlins made to specification. Please inquire for availability by region.



## RETAINER TEE STUD: FOR RIGID INSULATION

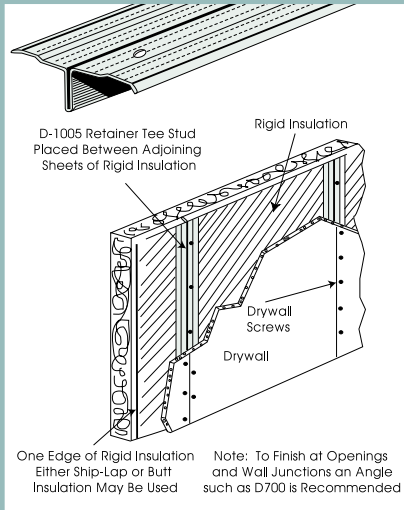

### D-1005 RETAINER TEE STUD

The Bailey Retainer Tee is specifically designed to hold rigid insulation against a masonry wall. The Tee is made from hot dipped galvanized steel with pierced holes for securing the Tee to the masonry wall. The top surface is knurled to easily accept screws to secure drywall. The Bailey Retainer Tee is placed between adjoining sheets of rigid insulation. Holes are 5/16" diameter spaced 6" o.c. to allow for greater flexibility.

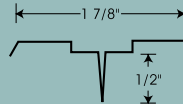

## RESILIENT CHANNEL SYSTEM: FOR SOUND CONTROL

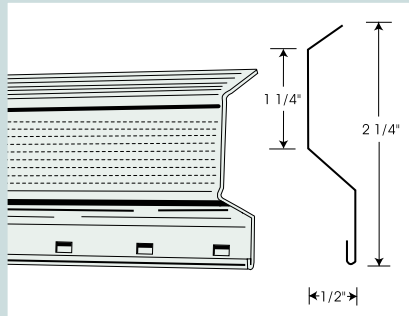

### D-1007 RESILIENT CHANNEL

A very effective low cost method for reducing sound transmission through walls. Especially suitable for multiple unit building, recording studio walls etc. Manufactured to ASTM standards. Many applications with STC values for resilient channel onto wood and steel are available in the National Building Code Table A-9.10.3.1.A

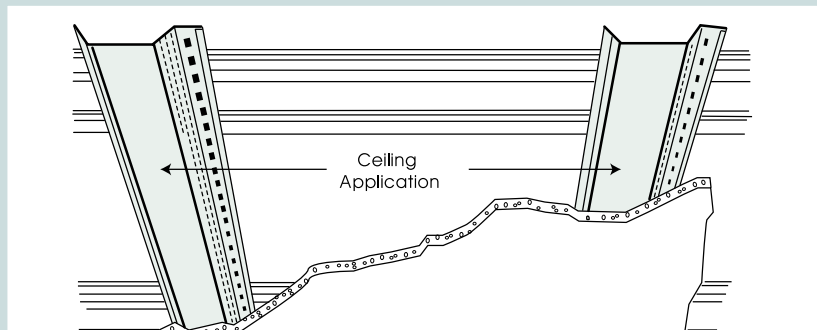
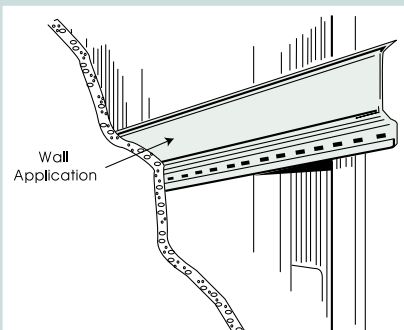





## FURRING CHANNELS & TOP HAT SECTIONS

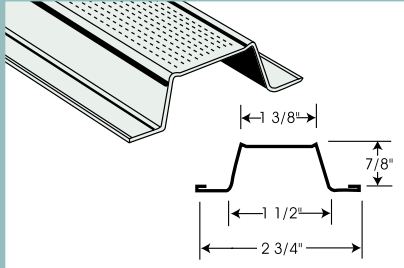

### D-1001 DRYWALL FURRING CHANNELS

Drywall Furring Channel is a very versatile hat-shaped metal channel, designed for "furring" out any surface for application of your final finish (ie. metal siding, drywall, etc.). In addition, furring channel, used in conjunction with cold rolled channels, is the ideal system for construction of a drywall ceiling. We have published span tables available for 18 mils (25ga) 33 mils (20ga).

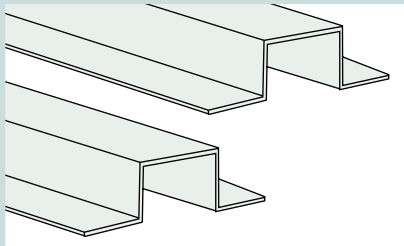

### TOP HAT SECTIONS

Similar to D-1001 Drywall Furring Channel, Top Hat Sections are designed for areas where a wider face or a deeper section is required (roof purlins, etc.).

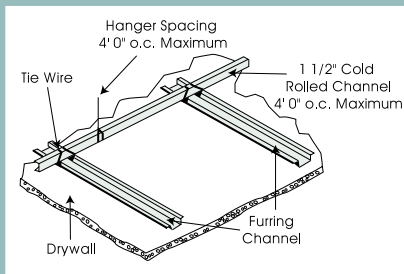

### SUSPENDED DRYWALL CEILING INSTALLATION

Install 1 1/2" cold rolled galvanized channel at 4' o.c. suspended from floor joists or deck using the specified hanger wire. (Lighter than #9 [gauge] wire should not be used). Drywall furring channel is installed perpendicular to the cold rolled channel at 16" o.c. Steel stud or D-700 1" x 2" angle may be used for perimeter connection of gypsum board, as shown in Soffit Construction Details.

## SOFFIT CONSTRUCTION DETAILS

### BRACED SOFFIT

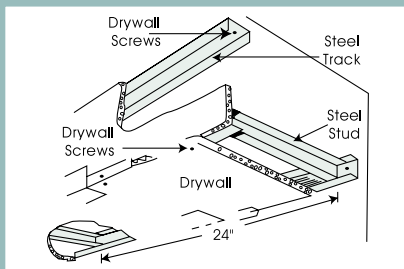

### UNBRACED SOFFIT

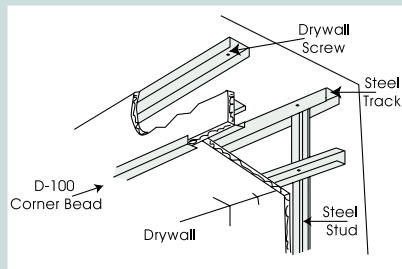

Note: For typical applications maximum width and or height should not exceed 24".



## STANDARDS



Applicable standards for Steel Stud Framing, Trims and Accessories for Non Structural Framing are as follows:

**PROFILE, STEEL THICKNESS AND DIMENSIONS – ASTM C645**  
(With permissible tolerance) for stud track and furring channel.

**GRADE OF STEEL – ASTM A1003**  
For sheet metal, metallic and non metallic coated

**COATING (GALVANIZING)**  
Zinc/galvanized coated steel to – **ASTM A653**  
Aluminum zinc coated steel to – **ASTM A792**

**INSTALLATION – ASTM C754**

**STANDARDS FOR TRIMS AND ACCESSORIES – ASTM C1047**



In addition to the products shown within this catalogue, **Bailey Metal Products** is a leading manufacturer of:

- Suspended ceiling grid systems
- Lightweight steel framing systems for axial and wind load bearing applications
- Metal lath and accessories for plastering
- Related fasteners and fittings
- Platinum, a series of Goldline® Paper Bead and Trims
- COMFLOR® Composite Floor System
- Brick Connectors
- Floor Joist Systems



## BAILEY METAL PRODUCTS LIMITED

**MONTREAL**  
LES PRODUITS METALLIQUES BAILEY LTEE  
5890 Avenue Andover  
Ville Mont-Royal QC H4T 1H4  
Tel: (514) 735 3455  
(800) 263 3455  
Fax: (514) 735 5052

**TORONTO**  
One Caldari Road  
Concord ON L4K 3Z9  
Tel: (905) 738 6738  
(800) 668 2154  
Fax: (905) 738 5712

**CALGARY**  
2515 Centre Avenue S.E.  
Calgary AB T2A 2L1  
Tel: (403) 248 3536  
(800) 665 2013  
Fax: (403) 248 0288

**EDMONTON**  
5710 Roper Road N.W., Suite 101  
Edmonton AB T6B 3G7  
Tel: (780) 462 5757  
(800) 563 1751  
Fax: (780) 465 3791

**VANCOUVER**  
7715 Anvil Way  
Surrey BC V3W 6A2  
Tel: (604) 590 5100  
(800) 818 2666  
Fax: (604) 599 5371