

Plank Panels: ROCKFON Acoustical Ceiling Panels

What is a Plank Panel?

A plank is any panel that has the longer edge greater than 2 times the shorter edge.

ROCKFON Standard Planks

20"x5', 2'x5', 2'x6', 2'x8'

Handling Planks

It is recommended that planks be handled by two installers when moving or installing them into the ceiling plane. A single installer may lift the panel unevenly and cause damage.

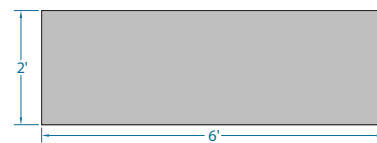
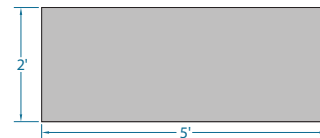
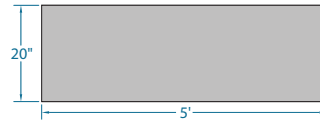

Installing Planks

Spacer bars are V-shaped and install quickly by pushing the notch onto the bulb of the suspension components. In addition, spacer bars can be locked in place by driving a screw through the web of the grid in the valley of the spacer bar. Spacer bars provide stabilization to grid components and are especially useful for long cross tees. 1 spacer bar is recommended at the center on 5' long tiles and 2 spacer bars, roughly at the 1/3 points, are recommended for 6' and 8' tiles. Spacer bars are required at locations of penetrations through the tiles, such as can lighting or sprinkler heads.

Spacer bars are available in 2' (826.00H) and 4' (824.00H) versions.

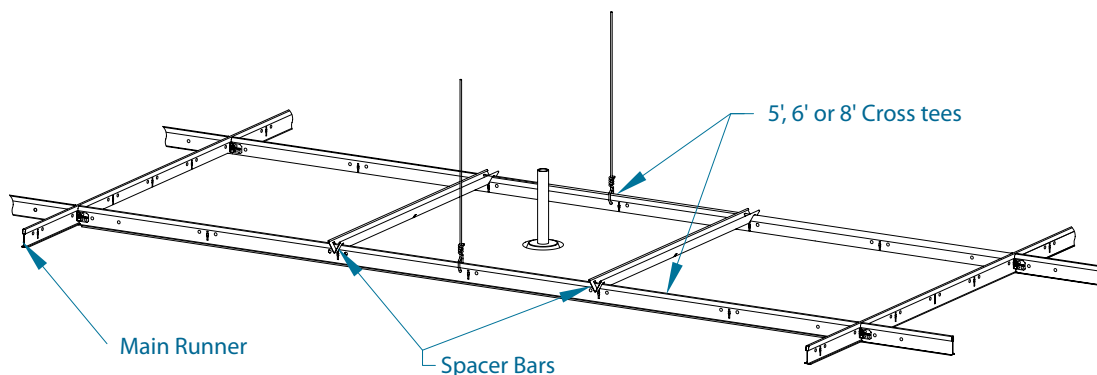
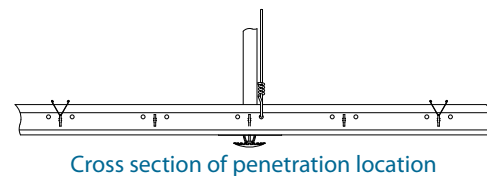
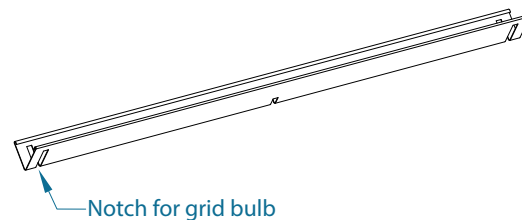

Plank Panels: ROCKFON Acoustical Ceiling Panels

Typical Layouts

When utilizing spacer bars, it is recommended to follow a pattern similar to what is outlined below. Adding the spacer bars as shown will add stability while maintaining accessibility to the plenum. Panels without spacer bars will remain accessible from below.

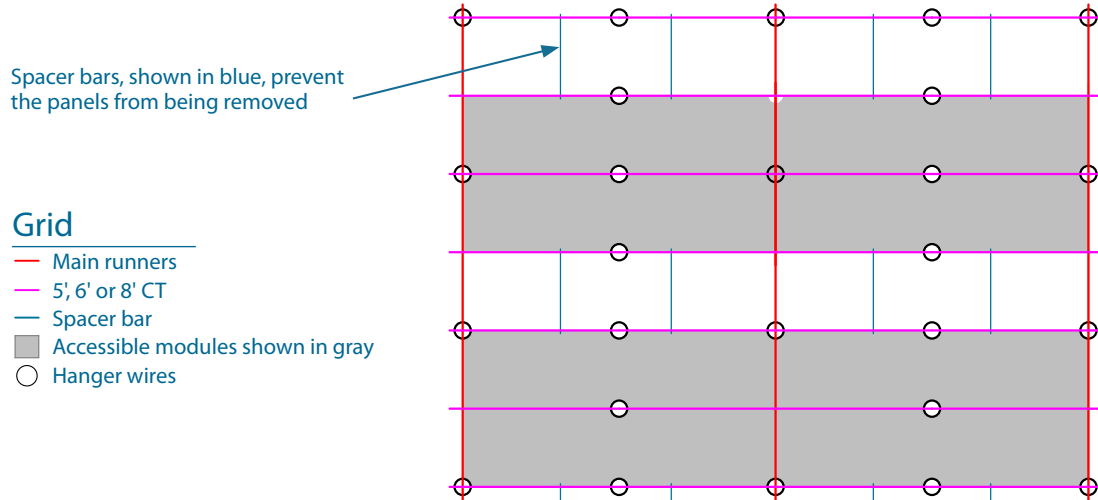

Panel Removal

Due to the spacer bars hanging into the accessible modules, the panel must be removed as shown below. Lifting the panel vertically will cause it to run into the spacer bar and prevent removal.

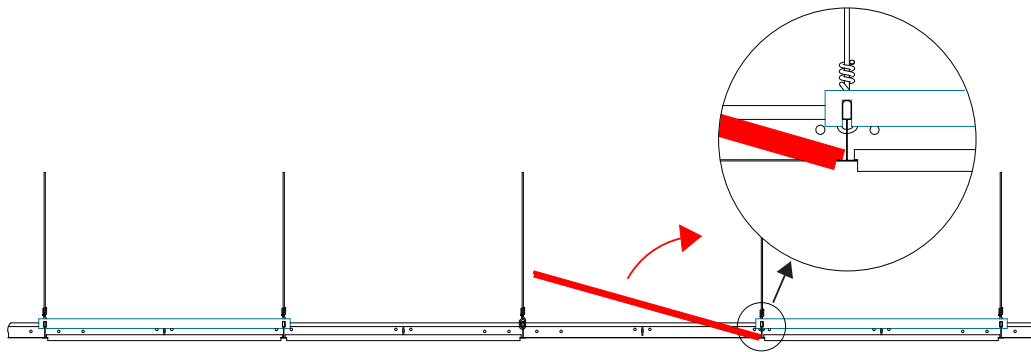

Have questions?

Contact the ROCKFON Technical Services Team by calling 800-323-7164, prompt 3 and we can provide assistance on your project.



ROCKFON 4849 SOUTH AUSTIN AVE., CHICAGO, IL 60638 / USA and Canada: 800-323-7164 / Fax: 800-222-3744 / rockfon.com